

Performances (Pour une persienne de 1219 x 1219 mm)	
Pourcentage d'air libre	39,82 %
Surface d'air libre	6,37 pi ² (0,592 m ²)
Vitesse dans la surface libre au début de la pénétration d'eau @ 0,010 oz/pi ² (3,05 gr/m ²) =	775 ppm (3,94 m/s)
Vitesse dans la surface libre @ perte de pression 0,15 po H ₂ O (3,81 mm H ₂ O) =	900 ppm (4,57 m/s)

Spécifications standard	
Matériel	Aluminium 6063-T5
Profondeur	50,8 mm (2")
Épaisseur de la lame	1,60 mm (0,063")
Épaisseur du cadre en "L"	2,06 mm (0,081")
Épaisseur du cadre en "U"	1,83 mm (0,072")
Angle des lames	45°
Centre en centre des lames	63,5 mm (2,5")
Grillage	Acier galvanisé
Fini	Aluminium Naturel
Montage	Mécanique
Quincaillerie	Acier zingué
Poids approximatif	2,31 lbs/pi ²

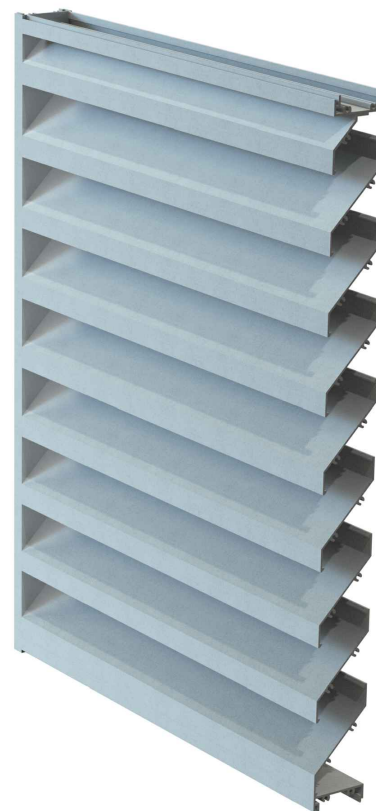

Perte de pression

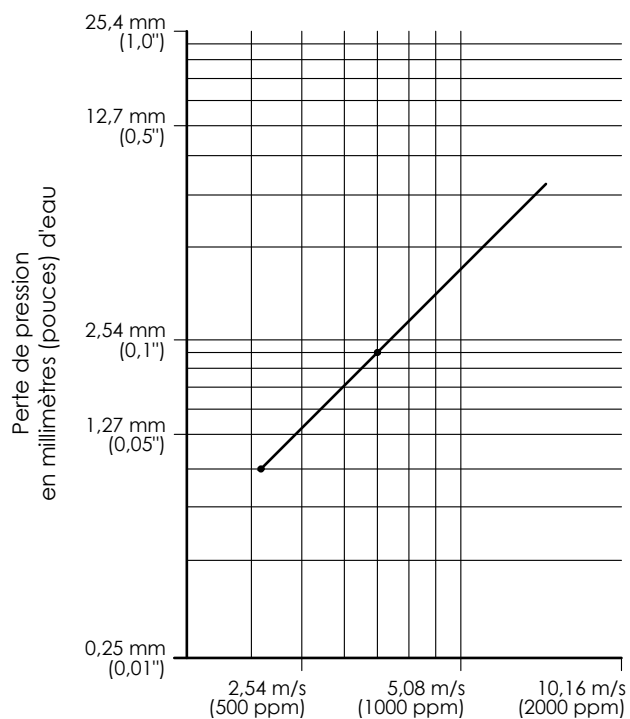

Vitesse de l'air au travers de la surface libre en mètre par seconde (pieds par minute)

Surface Libre (pi² & m²)

Largeur de la persienne

po	12	18	24	30	36	42	48	54	60	66	72
m	0.30	0.46	0.61	0.76	0.91	1.07	1.22	1.37	1.52	1.68	1.83
12	0.28	0.43	0.58	0.73	0.85	1.00	1.15	1.30	1.45	1.60	1.75
0.30	0.026	0.040	0.054	0.068	0.079	0.093	0.107	0.121	0.134	0.148	0.162
18	0.53	0.81	1.10	1.38	1.59	1.88	2.16	2.44	2.73	3.01	3.29
0.46	0.049	0.076	0.102	0.128	0.148	0.174	0.201	0.227	0.253	0.280	0.306
24	0.70	1.07	1.44	1.81	2.09	2.46	2.83	3.20	3.57	3.94	4.31
0.61	0.065	0.099	0.134	0.168	0.194	0.228	0.263	0.297	0.332	0.366	0.401
30	0.92	1.41	1.90	2.39	2.76	3.25	3.74	4.23	4.72	5.21	5.70
0.76	0.085	0.131	0.176	0.222	0.256	0.302	0.347	0.393	0.438	0.484	0.529
36	1.13	1.73	2.34	2.94	3.39	3.99	4.60	5.20	5.80	6.40	7.01
0.91	0.105	0.161	0.217	0.273	0.315	0.371	0.427	0.483	0.539	0.595	0.651
42	1.31	2.02	2.72	3.42	3.94	4.64	5.35	6.05	6.75	7.45	8.15
1.07	0.122	0.187	0.252	0.318	0.366	0.432	0.497	0.562	0.627	0.692	0.757
48	1.57	2.40	3.24	4.07	4.70	5.54	6.37	7.21	8.04	8.88	9.71
1.22	0.146	0.223	0.301	0.378	0.437	0.514	0.592	0.669	0.747	0.825	0.902
54	1.65	2.53	3.41	4.30	4.96	5.84	6.72	7.60	8.48	9.36	10.24
1.37	0.153	0.235	0.317	0.399	0.460	0.542	0.624	0.706	0.788	0.870	0.952
60	1.96	3.01	4.06	5.10	5.89	6.93	7.98	9.03	10.07	11.12	12.17
1.52	0.182	0.280	0.377	0.474	0.547	0.644	0.741	0.839	0.936	1.033	1.130
66	2.17	3.33	4.49	5.65	6.52	7.68	8.84	10.00	11.16	12.32	13.48
1.68	0.202	0.310	0.417	0.525	0.606	0.714	0.821	0.929	1.037	1.144	1.252
72	2.36	3.62	4.87	6.13	7.07	8.33	9.59	10.85	12.10	13.36	14.62
1.83	0.219	0.336	0.453	0.570	0.657	0.774	0.891	1.008	1.124	1.241	1.358
78	2.61	4.00	5.39	6.79	7.83	9.22	10.61	12.01	13.40	14.79	16.18
1.98	0.242	0.372	0.501	0.630	0.727	0.857	0.986	1.115	1.245	1.374	1.503
84	2.78	4.27	5.75	7.23	8.35	9.83	11.31	12.80	14.28	15.77	17.25
2.13	0.258	0.396	0.534	0.672	0.775	0.913	1.051	1.189	1.327	1.465	1.603

Spécifications

Matériel	Aluminium 6063-T5
Lames	Épaisseur de 1,60 mm (0,063")
Cadre en L	Épaisseur de 2,06 mm (0,081")
Cadre en U	Épaisseur de 1,83 mm (0,072")

Cadres disponibles

- Cadre en "L"
- Cadre en "U"
- Meneaux dissimulés (lames continues)
- Meneaux apparents (cadres emboîtés)

Finis disponibles

- Naturel
- Anodisé naturel 10 microns
- Anodisé naturel 18 microns
- Anodisé bronze pâle
- Anodisé bronze architectural
- Anodisé champagne
- Anodisé noir
- Peinture polyuréthane acrylique *
- Peinture liquide super durable *
- Émail cuit Duranar *
- Émail cuit Duranar XL *
- Peinture en poudre *

Couleur : _____

* Peint sur les surfaces visible de l'extérieur seulement

Grillages et accessoires

- Acier galvanisé (standard)
- Aluminium déployé
- Aluminium tissé
- Acier inoxydable
- Moustiquaire en aluminium tissé
- Moustiquaire en fibre de verre
- Moustiquaire en filtre média
- Cadre à grillage/moustiquaire
- Panneau obturateur non isolé 0,8 mm [0,032"]
- Panneau obturateur isolé 50 mm [2"]

Fini : _____

Couleur : _____

Autres : _____

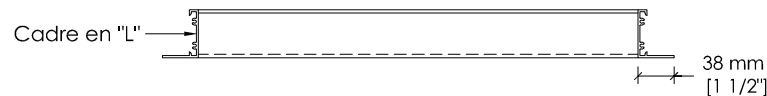
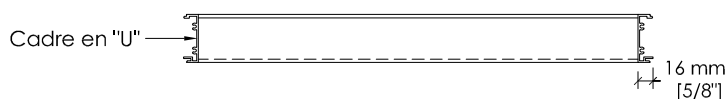
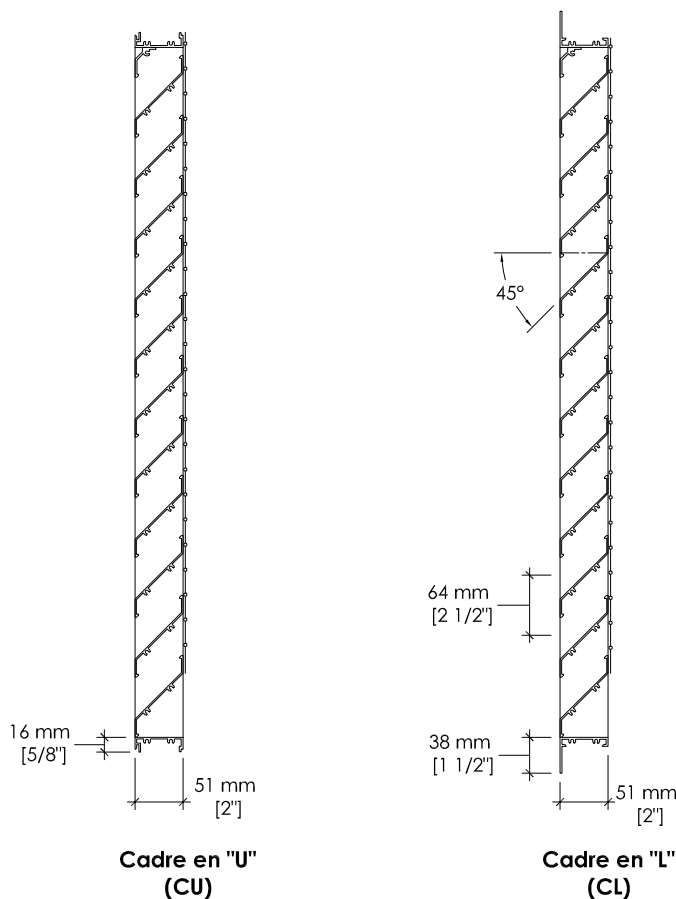

Projet

Nom : _____

Arch./Ing.: _____

Entrepreneur : _____

OF / # Commande : _____

Date : _____

Élévation (vue de l'extérieur)

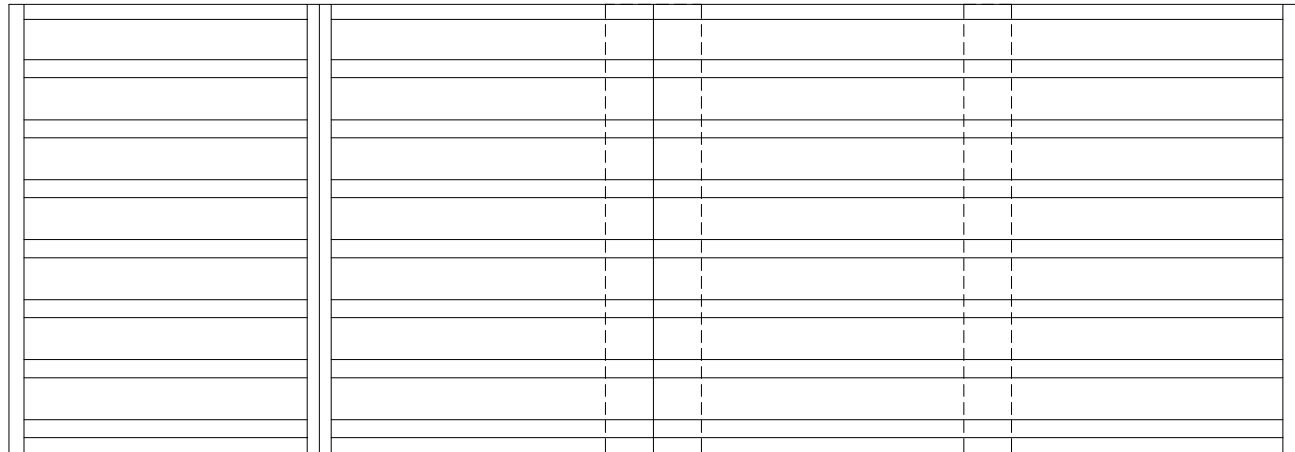

Coupe

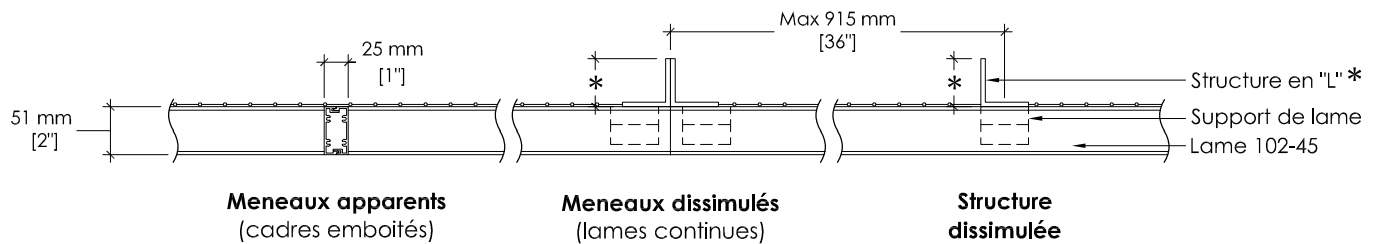

Structure de la persienne

Pour les persiennes de plus de 915 mm (36") de largeur, il est nécessaire de mettre une structure à l'arrière de la persienne

		* Dimensions de la structure de la persienne
Hauteur de la persienne	moins de 2438 mm (96")	Angle de 38 x 38 x 4,7 mm (1 1/2" x 1 1/2" x 3/16")
	de 2438 mm (96") à 3658 mm (144")	Angle de 51 x 51 x 4,7 mm (2" x 2" x 3/16")
	plus de 3658 mm (144")	veuillez communiquer avec le département d'ingénierie

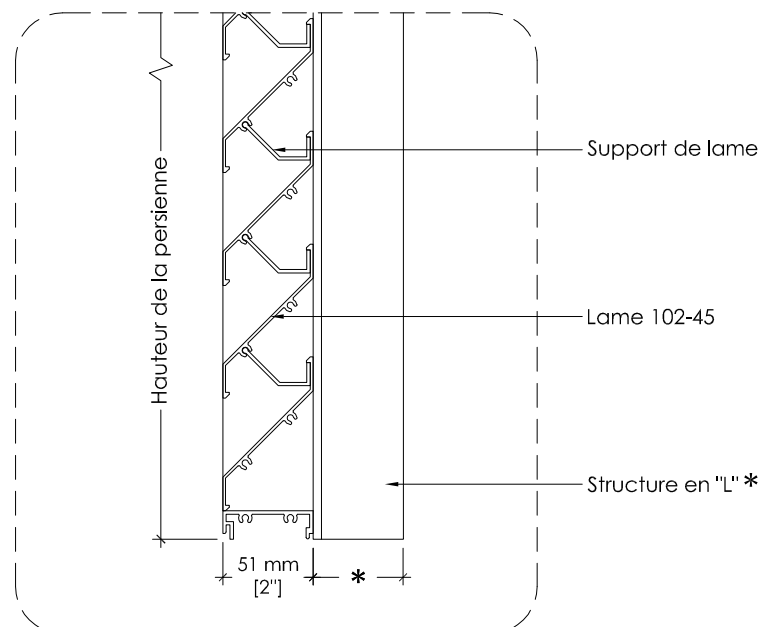

Formes

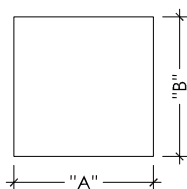

Rectangle / carré

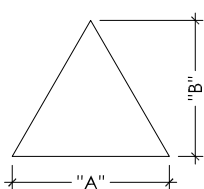

Triangle

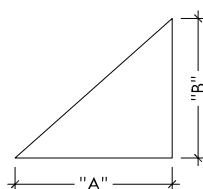

Triangle gauche

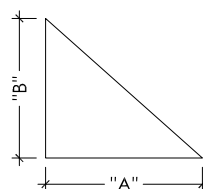

Triangle droit

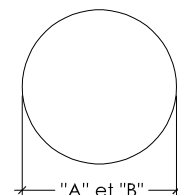

Ronde

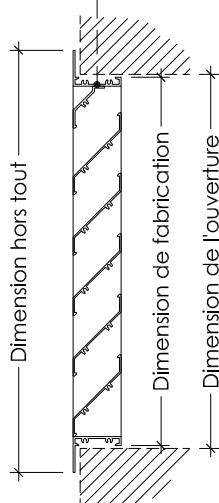
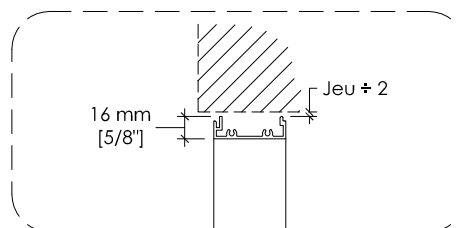
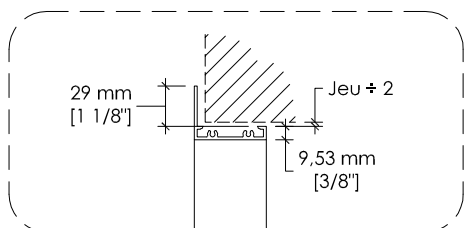

Cadre en "L" (CL)

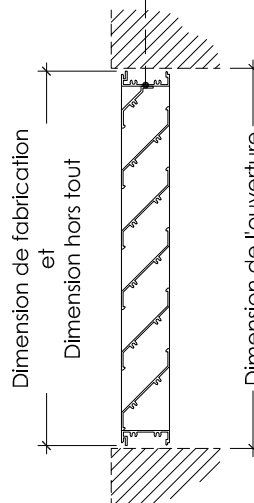

Cadre en "U" (CU)

Dimensions hors tout

Dimensions de l'ouverture

Dimensions de fabrication

Item	Qté	Dimensions		Nombre de section		Jeu (6 mm (1/4") minimum recommandé)	Remarques
		Largeur "A"	Hauteur "B"	Large	Haut		