

| Performances (Pour une persienne de 1219 x 1219 mm) | |
|---|--|
| Pourcentage d'air libre | 51,78 % |
| Surface d'air libre | 8,29 pi ² (0,770 m ²) |
| Vitesse dans la surface libre au début de la pénétration d'eau @ 0,010 oz/pi ² (3,05 gr/m ²) = | 1115 ppm (5,66 m/s) |
| Vitesse dans la surface libre @ perte de pression 0,15 po H ₂ O (3,81 mm H ₂ O) = | 990 ppm (5,03 m/s) |

| Spécifications standard | |
|-----------------------------------|--------------------------|
| Matériel | Aluminium 6063-T5 |
| Profondeur | 101,6 mm (4") |
| Épaisseur de la lame | 2,06 mm (0,081") |
| Épaisseur du cadre en "L" | 2,06 mm (0,081") |
| Épaisseur du cadre en "U" | 1,83 mm (0,072") |
| Angle des lames | 45° |
| Centre en centre des lames | 88,90 mm (3,50") |
| Grillage | Acier galvanisé |
| Fini | Aluminium Naturel |
| Montage | Mécanique |
| Quincaillerie | Acier zingué |
| Poids approximatif | 3,44 lbs/pi ² |

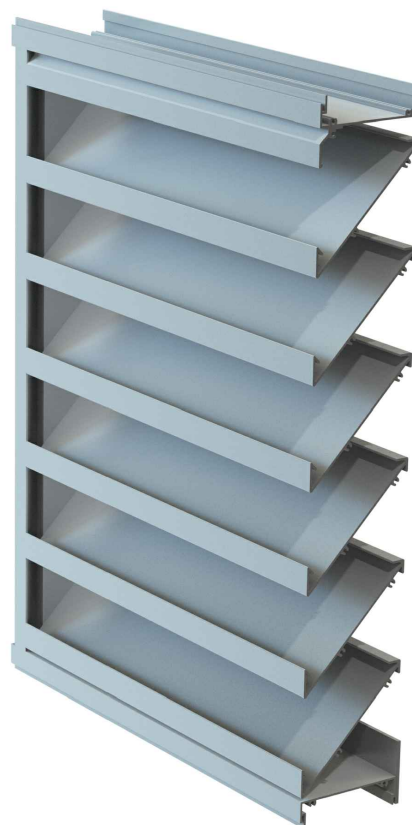

Perte de pression

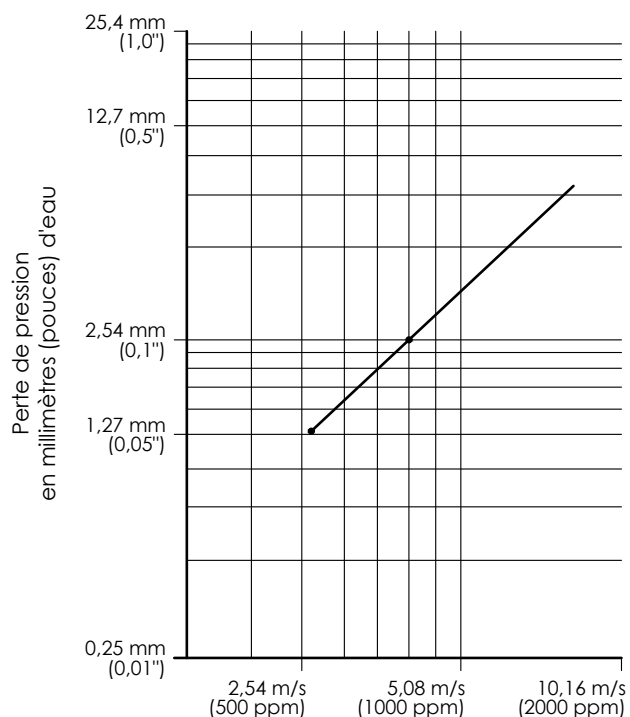

Vitesse de l'air au travers de la surface libre en mètre par seconde (pieds par minute)

Surface Libre (pi² & m²)

Largeur de la persienne

| po | 12 | 18 | 24 | 30 | 36 | 42 | 48 | 54 | 60 | 66 | 72 |
|-----------|-------------|-------------|-------------|-------------|--------------|--------------|--------------|--------------|--------------|--------------|--------------|
| m | 0.30 | 0.46 | 0.61 | 0.76 | 0.91 | 1.07 | 1.22 | 1.37 | 1.52 | 1.68 | 1.83 |
| 12 | 0.33 | 0.50 | 0.68 | 0.85 | 1.03 | 1.20 | 1.38 | 1.51 | 1.69 | 1.86 | 2.04 |
| 0.30 | 0.031 | 0.047 | 0.063 | 0.079 | 0.096 | 0.112 | 0.128 | 0.140 | 0.157 | 0.173 | 0.189 |
| 18 | 0.64 | 0.97 | 1.31 | 1.65 | 1.99 | 2.33 | 2.67 | 2.92 | 3.26 | 3.60 | 3.94 |
| 0.46 | 0.059 | 0.091 | 0.122 | 0.154 | 0.185 | 0.217 | 0.248 | 0.272 | 0.303 | 0.335 | 0.366 |
| 24 | 0.92 | 1.40 | 1.89 | 2.38 | 2.87 | 3.36 | 3.84 | 4.21 | 4.70 | 5.19 | 5.68 |
| 0.61 | 0.085 | 0.130 | 0.176 | 0.221 | 0.266 | 0.312 | 0.357 | 0.391 | 0.437 | 0.482 | 0.527 |
| 30 | 1.15 | 1.76 | 2.38 | 2.99 | 3.60 | 4.22 | 4.83 | 5.29 | 5.91 | 6.52 | 7.13 |
| 0.76 | 0.107 | 0.164 | 0.221 | 0.278 | 0.335 | 0.392 | 0.449 | 0.492 | 0.549 | 0.606 | 0.663 |
| 36 | 1.42 | 2.18 | 2.93 | 3.69 | 4.45 | 5.20 | 5.96 | 6.53 | 7.28 | 8.04 | 8.80 |
| 0.91 | 0.132 | 0.202 | 0.272 | 0.343 | 0.413 | 0.483 | 0.554 | 0.606 | 0.677 | 0.747 | 0.817 |
| 42 | 1.73 | 2.66 | 3.58 | 4.50 | 5.43 | 6.35 | 7.27 | 7.97 | 8.89 | 9.81 | 10.74 |
| 1.07 | 0.161 | 0.247 | 0.333 | 0.418 | 0.504 | 0.590 | 0.676 | 0.740 | 0.826 | 0.912 | 0.998 |
| 48 | 1.97 | 3.02 | 4.08 | 5.13 | 6.18 | 7.23 | 8.29 | 9.07 | 10.13 | 11.18 | 12.23 |
| 1.22 | 0.183 | 0.281 | 0.379 | 0.476 | 0.574 | 0.672 | 0.770 | 0.843 | 0.941 | 1.038 | 1.136 |
| 54 | 2.21 | 3.39 | 4.56 | 5.74 | 6.92 | 8.10 | 9.27 | 10.16 | 11.33 | 12.51 | 13.69 |
| 1.37 | 0.205 | 0.314 | 0.424 | 0.533 | 0.643 | 0.752 | 0.861 | 0.943 | 1.053 | 1.162 | 1.272 |
| 60 | 2.52 | 3.86 | 5.20 | 6.54 | 7.88 | 9.22 | 10.56 | 11.57 | 12.91 | 14.25 | 15.59 |
| 1.52 | 0.234 | 0.358 | 0.483 | 0.608 | 0.732 | 0.857 | 0.981 | 1.075 | 1.199 | 1.324 | 1.449 |
| 66 | 2.79 | 4.29 | 5.78 | 7.27 | 8.76 | 10.25 | 11.74 | 12.86 | 14.35 | 15.84 | 17.33 |
| 1.68 | 0.260 | 0.398 | 0.537 | 0.675 | 0.814 | 0.952 | 1.091 | 1.194 | 1.333 | 1.471 | 1.610 |
| 72 | 3.03 | 4.65 | 6.26 | 7.88 | 9.49 | 11.11 | 12.73 | 13.94 | 15.55 | 17.17 | 18.79 |
| 1.83 | 0.281 | 0.432 | 0.582 | 0.732 | 0.882 | 1.032 | 1.182 | 1.295 | 1.445 | 1.595 | 1.745 |
| 78 | 3.30 | 5.06 | 6.82 | 8.58 | 10.33 | 12.09 | 13.85 | 15.17 | 16.93 | 18.69 | 20.45 |
| 1.98 | 0.306 | 0.470 | 0.633 | 0.797 | 0.960 | 1.124 | 1.287 | 1.410 | 1.573 | 1.736 | 1.900 |
| 84 | 3.61 | 5.54 | 7.46 | 9.39 | 11.32 | 13.24 | 15.17 | 16.61 | 18.54 | 20.46 | 22.39 |
| 2.13 | 0.336 | 0.514 | 0.693 | 0.872 | 1.051 | 1.230 | 1.409 | 1.543 | 1.722 | 1.901 | 2.080 |

Spécifications

| | |
|-------------------|-------------------------------|
| Matériel | Aluminium 6063-T5 |
| Lames | Épaisseur de 2,06 mm (0,081") |
| Cadre en L | Épaisseur de 2,06 mm (0,081") |
| Cadre en U | Épaisseur de 1,83 mm (0,072") |

Cadres disponibles

- Cadre en "L"
- Cadre en "U"
- Meneaux dissimulés (lames continues)
- Meneaux apparents (cadres emboîtés)

Finis disponibles

- Naturel
- Anodisé naturel 10 microns
- Anodisé naturel 18 microns
- Anodisé bronze pâle
- Anodisé bronze architectural
- Anodisé champagne
- Anodisé noir
- Peinture polyuréthane acrylique *
- Peinture liquide super durable *
- Émail cuit Duranar *
- Émail cuit Duranar XL *
- Peinture en poudre *

Couleur : _____

* Peint sur les surfaces visible de l'extérieur seulement

Grillages et accessoires

- Acier galvanisé (standard)
- Aluminium déployé
- Aluminium tissé
- Acier inoxydable
- Moustiquaire en aluminium tissé
- Moustiquaire en fibre de verre
- Moustiquaire en filtre média
- Cadre à grillage/moustiquaire
- Panneau obturateur non isolé 0,8 mm [0,032"]
- Panneau obturateur isolé 50 mm [2"]

Finis : _____

Couleur : _____

Autres : _____

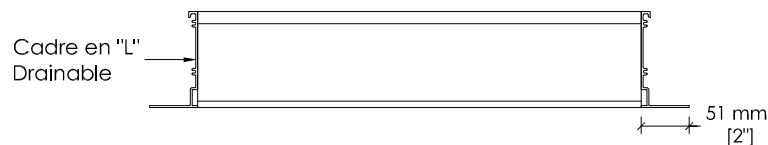
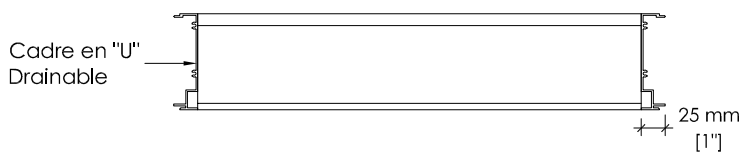
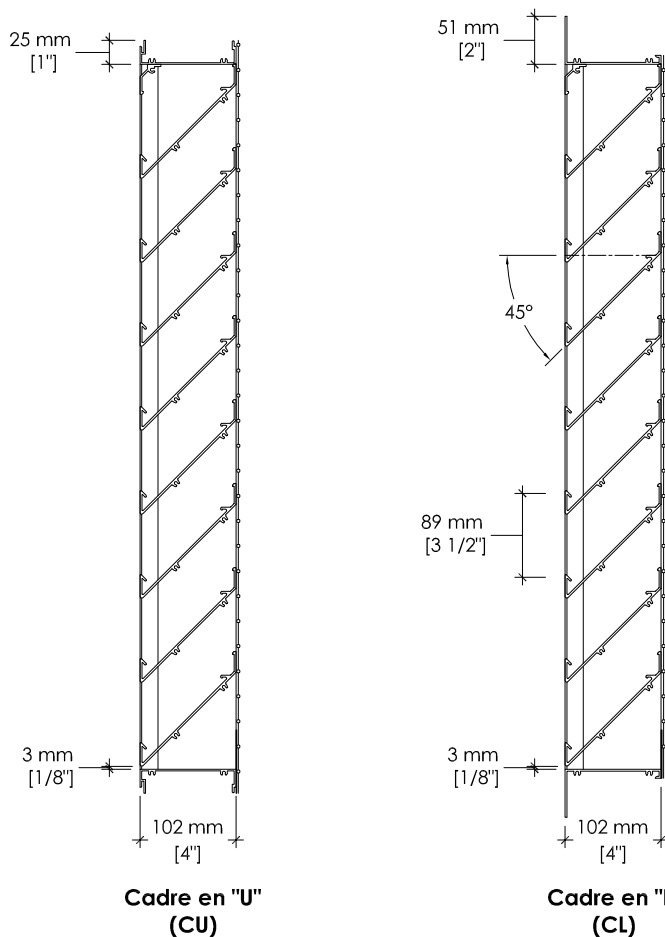

Projet

Nom : _____

Arch./Ing.: _____

Entrepreneur : _____

OF / # Commande : _____

Date : _____

Élévation (vue de l'extérieur)

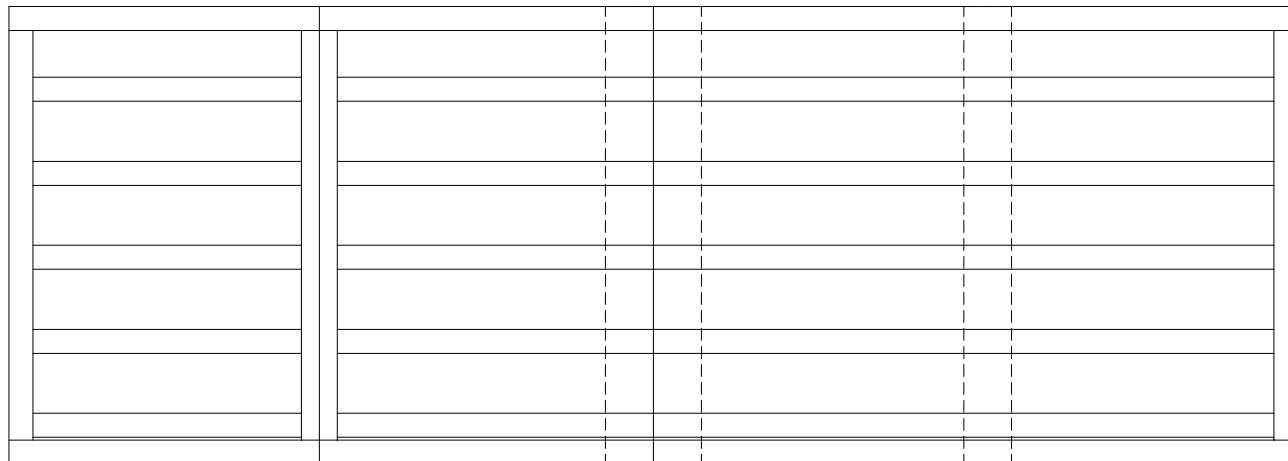

Coupe

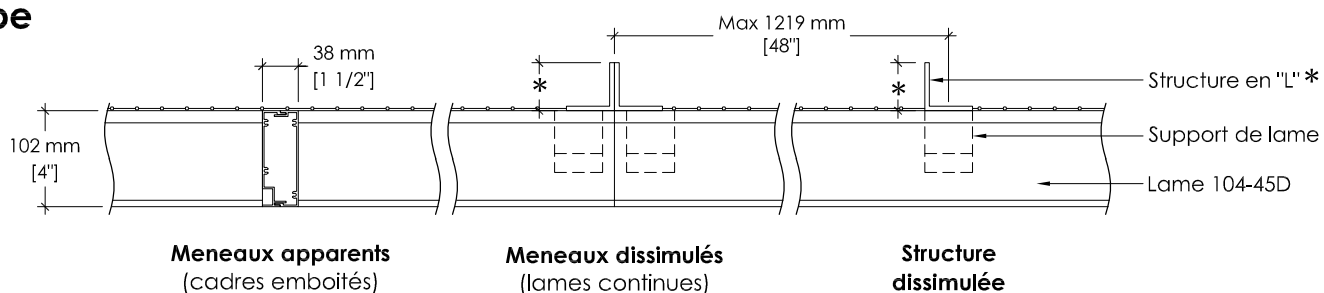

Structure de la persienne

Pour les persiennes de plus de 1220 mm (48") de largeur, il est nécessaire de mettre une structure à l'arrière de la persienne

| | | * Dimensions de la structure de la persienne |
|-------------------------|-----------------------------------|---|
| Hauteur de la persienne | moins de 2438 mm (96") | Angle de 38 x 38 x 4,7 mm (1 1/2" x 1 1/2" x 3/16") |
| | de 2438 mm (96") à 3658 mm (144") | Angle de 51 x 51 x 4,7 mm (2" x 2" x 3/16") |
| | plus de 3658 mm (144") | veuillez communiquer avec le département d'ingénierie |

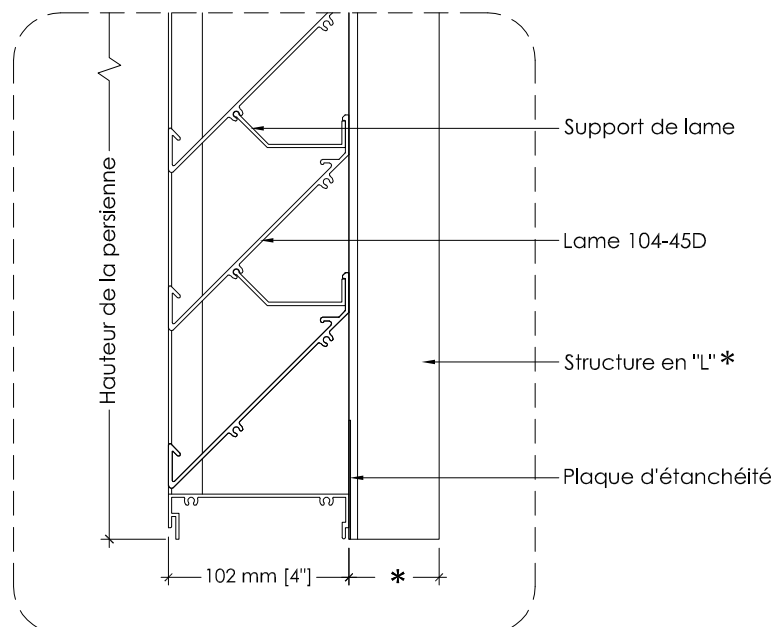

Formes

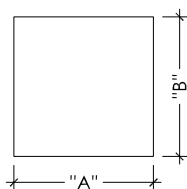

Rectangle / carré

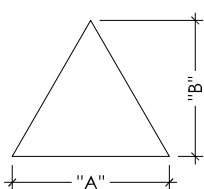

Triangle

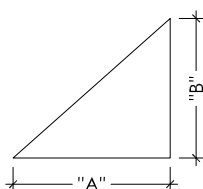

Triangle gauche

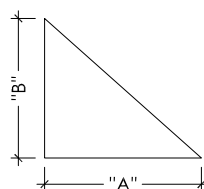

Triangle droit

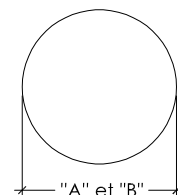

Ronde

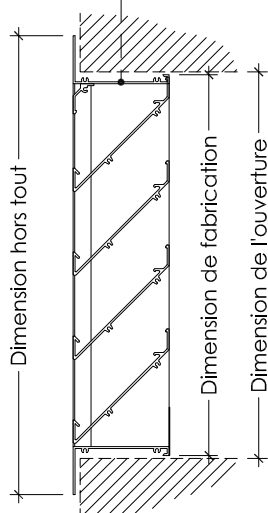
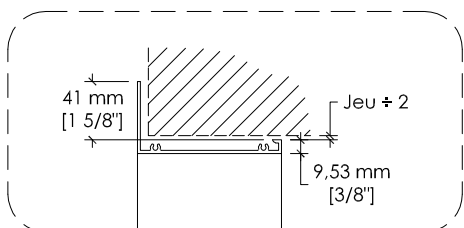

Cadre en "L" (CL)

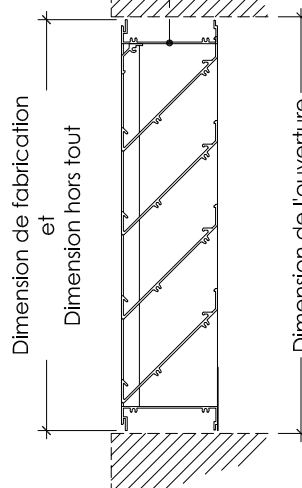
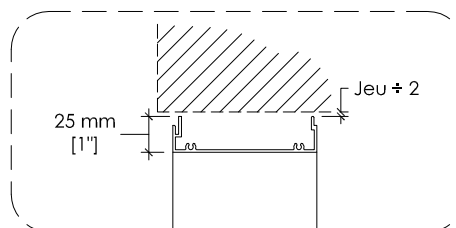

Cadre en "U" (CU)

Dimensions hors tout

Dimensions de l'ouverture

Dimensions de fabrication

| Item | Qté | Dimensions | | Nombre de section | | Jeu (6 mm (1/4") minimum recommandé) | Remarques |
|------|-----|-------------|-------------|-------------------|------|---|-----------|
| | | Largeur "A" | Hauteur "B" | Large | Haut | | |
| | | | | | | | |
| | | | | | | | |
| | | | | | | | |
| | | | | | | | |
| | | | | | | | |
| | | | | | | | |
| | | | | | | | |